

KAMEI 510

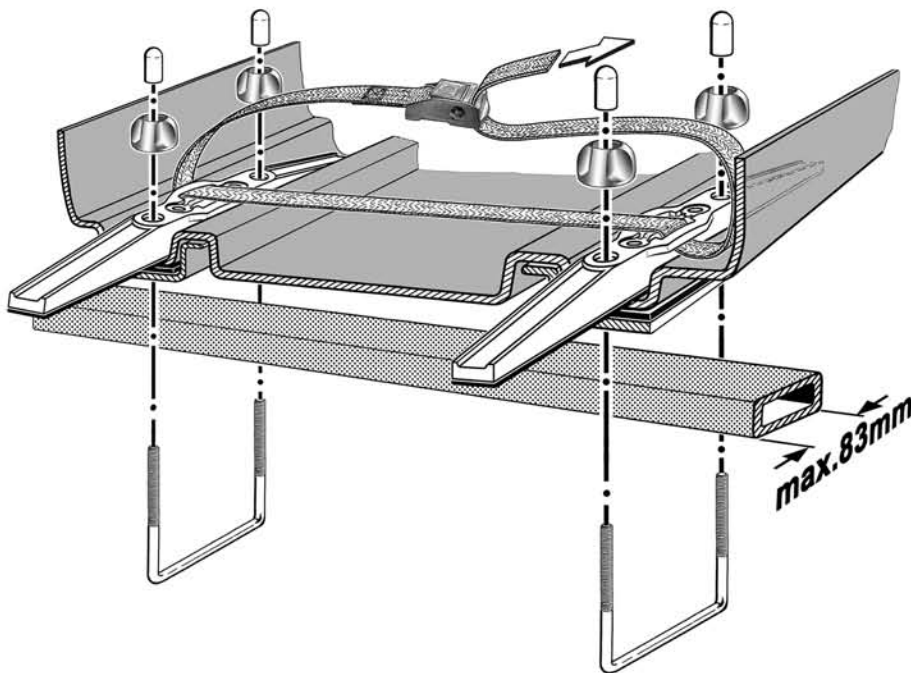

Art.-Nr. 0 52003 10

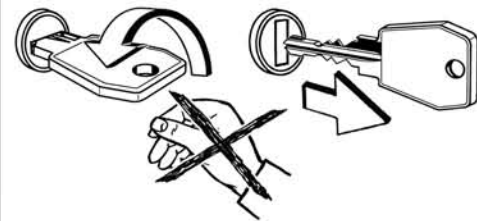
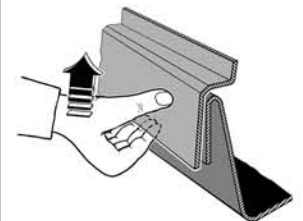
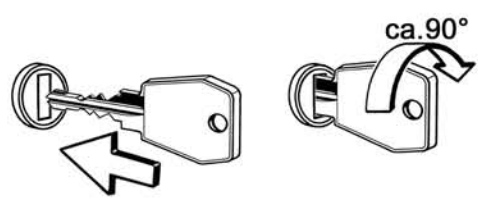
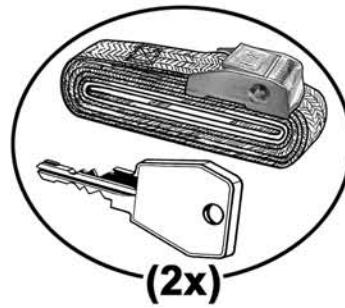
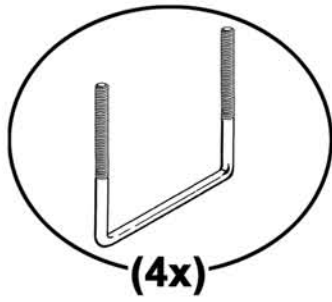
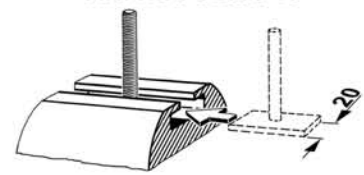

Art.-Nr. 0 52004 10

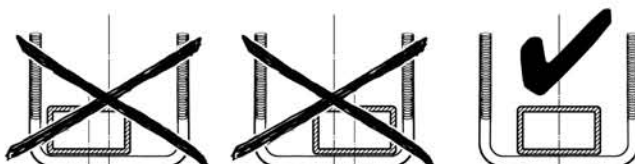
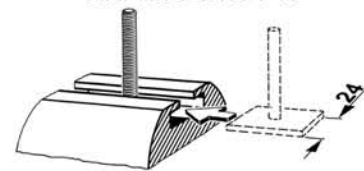

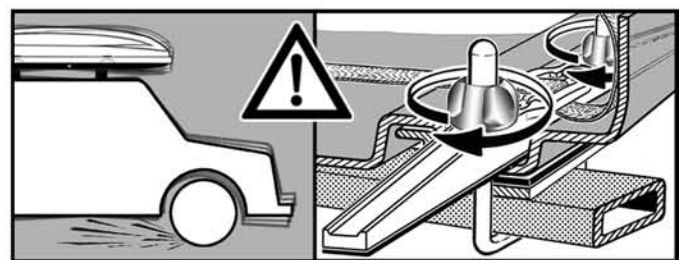
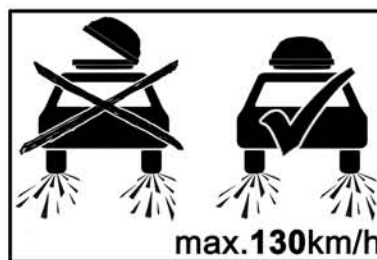
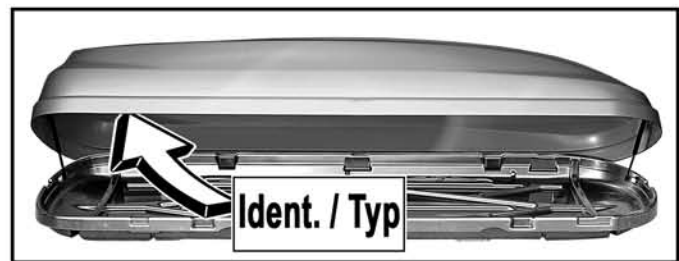
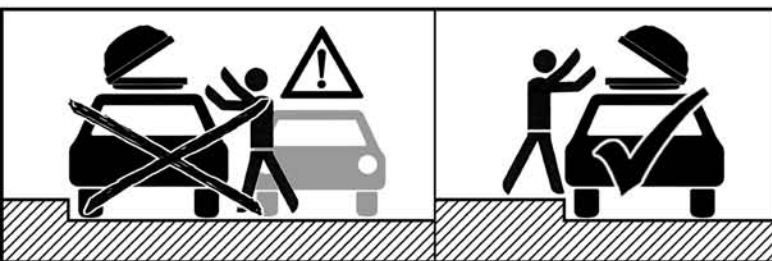
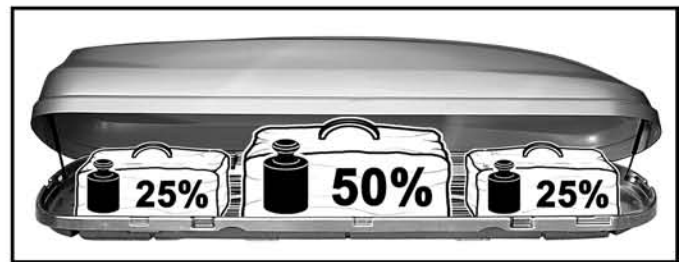
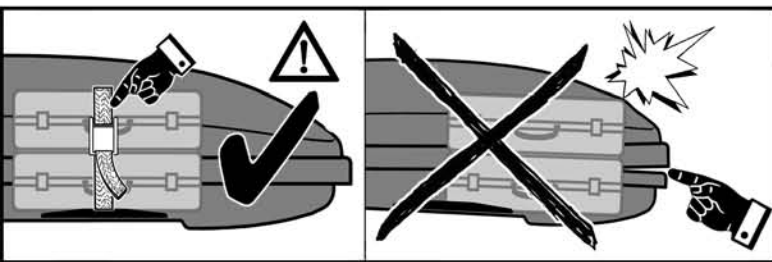
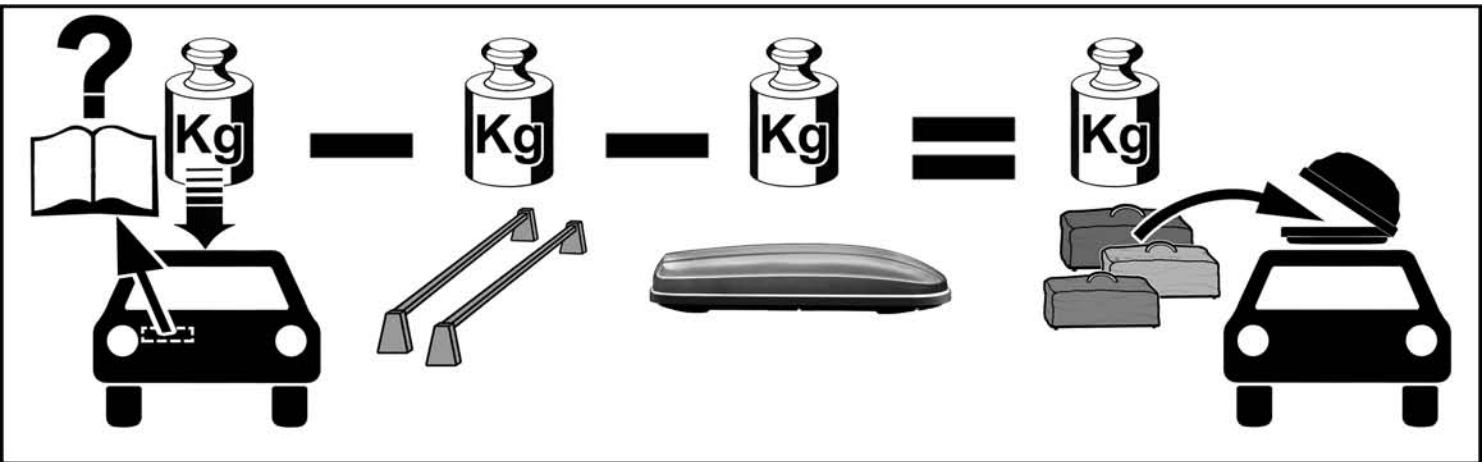
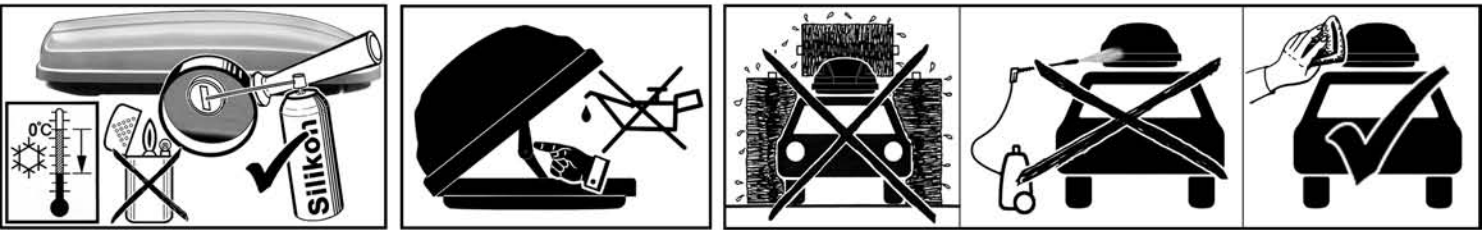
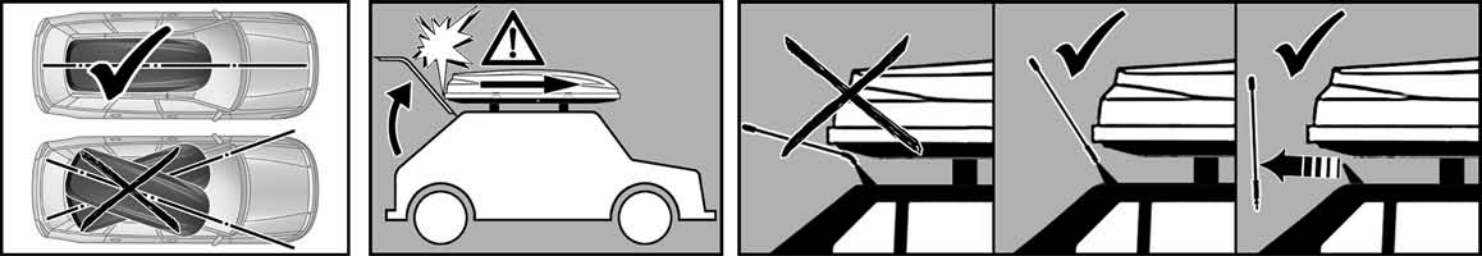

Dachcontainer Typ 81200

Haupt-Verkaufsbezeichnung Auch andere Verkaufsbezeichnungen sind genehmigt	Maße			Volumen	Gewichte		
	Länge cm	Breite cm	Höhe cm	Schüttgut Liter	Eigengewicht kg	zulässige Tragfähigkeit kg	Maximalgewicht beladen kg
KAMEI 510	200	90	44	510	18	75	93